

User Manual

Online Running Soft Starter



Safety Clauses

Thanks for your using intelligent motor online soft starter, this product is used for three-phase squirrel cage induction motor soft starting and soft stopping control. Before using, please carefully read and understand the contents of this manual.

In the process of using the soft starter, please note the following Safety Clauses:



Please check this user manual carefully before using the product.



Only the technical person is allowed to install the product.



To be sure that the motor is correctly matched with the soft starter.



It is forbid to connect capacitors to the output terminals (U V W).



Please seal the terminal switch insulation glue after finishing connect them.



The soft starter and its enclosures must be fixedly earthed.



During the maintenance and repair, the input must be off-power.

This user manual content may be changed due to technical reasons or modified. We reserve the updating right.

Table of Contents

1. Online Running Soft Starter	1
1.1 Online running soft starter profile	1
1.2 The main feature of online running soft starter	1
1.3 The main function.....	1
1.4 Technical specification.....	2
2. Nameplate Explanation and Inspection	3
3. Usage Condition and Installation.....	4
3.1 The usage condition.....	4
3.2 The installation requirement.....	4
3.3 The installation dimensions.....	5
3.4 Installation diagram	6
4. Connection and External Terminal.....	7
4.1 The external terminal.....	7
4.3 The communication interfaces.....	7
5. Control Panel and Operation	9
5.1 The operation of control panel.....	9
5.2 Parameters set and explanation.....	10
5.3 Parameters code function explanation.....	12
5.4 Helping message and explanation	13
6. Protection Functions and Directions.....	14
6.1 Protection classes and explanation	14
7. Test Run and Application	16
7.1 Power on to test running.....	16
7.2 The starting mode and application.....	18
7.2.1 Current-limit to start.....	18
7.2.2 Voltage ramp to start.....	18
7.2.3 Torque control + current limit or + voltage ramp to start.....	19
7.2.4 Current ramp to start	19
7.2.5 Voltage current-limiting double closed-loop start	20
7.3 The stopping mode and application.....	20
7.3.1 Soft-stopping Mode.....	20
7.3.2 Free-stopping Mode	20
7.4 Special application.....	20
7.5 Application examples	21
8. Online Running Soft Starter Cabinet.....	22
8.1 Product Function	22
8. The structure and installation method.....	23
8.3 The operation of control panel.....	24
8.4 Operation procedures and cautions.....	25
Quality Warranty	26

1. Online Running Soft Starter

1.1 Online running soft starter profile

Online running soft starter, the use of intelligent digital control; With the single chip processor as the intelligence center, thyristor module for actuators for full automatic control motor. It applies various squirrel-cage asynchronous motor control of load, the motor can smooth starting under any working conditions, protect the drag system, reduce the starting current impact on power grid, ensure reliable motor starting. Smoothly soft stopping function can effectively solve the inertial system surge problem, eliminate the drag system of inertial impact, that is traditional equipment cannot be achieved. Intelligent digital online running soft start equipment system with the complete protection function, extend the service life of the system, reduce the cost of system cost, improve the reliability of system and compatible with all the functions of starting equipment; It is a new ideal alternative for traditional star triangle starter and self-coupling decompression starter.

1.2 The main feature of online running soft starter

Reliable quality	<ul style="list-style-type: none"> ● The computer simulation design. ● SMT production process. ● Good EMC performance. ● The machine before delivery on the high temperature aging, vibration test.
Perfect and reliable system protection function	<ul style="list-style-type: none"> ● Protection of no voltage, less voltage and over voltage. ● Protection of overheating and starting time too long. ● Protection of Input phase lost, output phase lost and 3phase unbalance. ● Protection of starting over current, running overload, and load short circuit protection.
Maintenance function	<ul style="list-style-type: none"> ● Fault self-diagnosis(short circuit, over voltage, less voltage, one phase grounded, motor overload, one phase lost, motor blocked, and intelligent software can inspect drag system working state). ● Combination of modular design, according to the fault display content, quick troubleshooting.
Independent intellectual property products	<ul style="list-style-type: none"> ● Independently software copyright. ● Motor starting and protection proprietary technology. ● Unique way to detect debug equipment and process.
Quick and thoughtful after-sales service	<ul style="list-style-type: none"> ● Reliable performances lay the foundation of qualified service and quality. ● Provide perfect system solution. ● The timely and thoughtful Consulting Services. ● Constantly improve the product performance according to user's opinion.

1.3 The main function

- Effectively reduce the starting current of the motor; Can reduce the distribution capacity, avoid grid expansion investment.
- Reduce the starting stress of motor and load equipment; Prolong the service life of the motor and related equipments.

1. Online Running Soft starter

- Soft stopping function can effectively solve the parking surge problem of inertial systems; That is a traditional starting equipment cannot be achieved.
- With six unique starting mode; To adapt to the complex motor and load, achieve perfect priming effect.
- With complete and reliable protection function; effectively protect the safety of motor and related production equipment.
- Online running soft starter, the application of network technology used motor control technology to adapt to the rapid development of electric power automation technology in the higher requirements.

1.4 Technical specification

Item		Description
Input Power Supply	Input Voltage	Three-phase 380V/480V/660 AC
	Frequency	50/60Hz
Adaptive Motor		Squirrel-cage three-phase asynchronous motor
Starting Times		It is recommended not to exceed 20 times per hour.
Control Mode		(1) Operation panel control. (2) Operation panel + external control. (3) External control. (4) External control + COM control. (5) Operation panel + external + COM control. (6) Operation panel + COM control. (7) COM control. (8) No start or stop operation.
Start Mode		(1) Current-limiting to start. (2) Voltage ramp to start. (3) Torque control + current-limiting to start. (4) Torque control + voltage ramp to start. (5) Current ramp to start. (6) Voltage current-limiting double closed-loop start.
Stop Mode		(1) Soft stop. (2) Free stop.
Protective Function		(1) Open loop protection for external instantaneous stop terminals. (2) Over-heat protection for soft starter. (3) Protection for too long starting time. (4) Input open phase protection. (5) Output open phase protection. (6) Unbalanced three-phase protection. (7) starting over current protection. (8) Running overload protection. (9) Under voltage protection for power voltage. (10) Overvoltage protection for power voltage. (11) Protection for fault parameter setting. (12) Load short circuit protection. (13) Auto restart or incorrect wiring protection. (14) Incorrect wiring protection of external control stop terminals.
Ambient	Place to be used	Indoor location with good ventilation free from corrosive gas and conductive dust.
	Altitude	Below 1000M. It have to rise the rate power when the altitude is more than 1000M.
	Temperature	-20 +45 °C
	Humidity	90%RH without dew condensation.
	Vibration	<0.5G
Structure	Protection Class	IP20
	Cooling Pattern	Fans cooling.

2. Nameplate Explanation and Inspection

Please check up the products before using, if in some problems; please do not hesitate to contact us with any request for additional information. Check-up the type of product whether it is the right one you order.

Nameplate and Model explanation:

Motor Soft Starter		CE
Model	□-□-015	
Rated Power	15KW	
Rated Input	3PH 380V AC 50~60Hz	
Rated Output	3PH 30A 50~60Hz	
		
RQ30152013030700001		

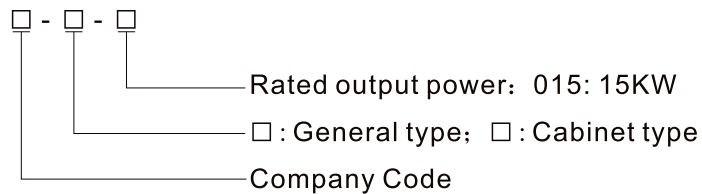

Diagram 2.1

- Check any damage to the product because of the transport, such as the spare parts are apart from the main body or the shell be damage etc.
- Check others, including the user's manual.

3. Usage Condition and Installation

It is strict rule for the users to use or install the online running soft starter according to the requirement; otherwise, it will be in bad result.

3.1 The usage condition

- **Power Supply:** City grid power, self-provided power, diesel oil dynamotor, 3-phase alternating current 380V/480V/660V \pm 15%, 50Hz or 60Hz. The power capacity of the online running soft start must meet the motor starting requirement.
- **Matched Motor:** Motor should be three phase squirrel asynchronous motor, and its power capacity must be matched with online running soft starters.
- **Starting Frequency:** The starting time is according to the loading equipments.
- **Cooling Mode:** Naturally wind cooling.
- **Protective Grade: IP20**
- **Environment Conditions:** when altitude is less than 1000m, the temperature of the environment should be between -20°C ~ 45 °C, relative humidity should be less than 90% RH, no vapor, no flammable, volatile, corrosive gas. No electric dirt, indoor installation, ventilated, vibration is less 0.5G.

3.2 The installation requirement

- The direction and distance of installation: In order to make sure that the online running soft starter be in good ventilation and heat dissipation, please install the product in vertical direction, and be sure the space around the product is enough. (See the following diagram 3.1)
- If the online running soft starter is installed in a box, please note that the ventilation is very good, as well as the above notes. (See the following diagram 3.1)

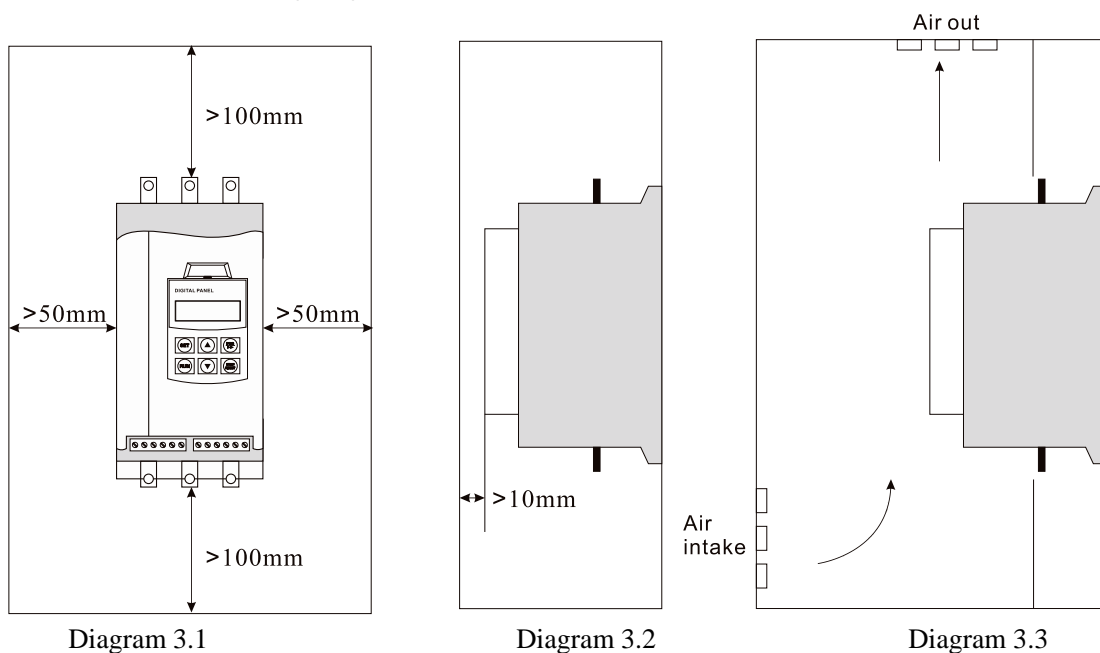

3.3 The installation dimensions

The external shape and installation dimensions of 11KW ~ 55KW.

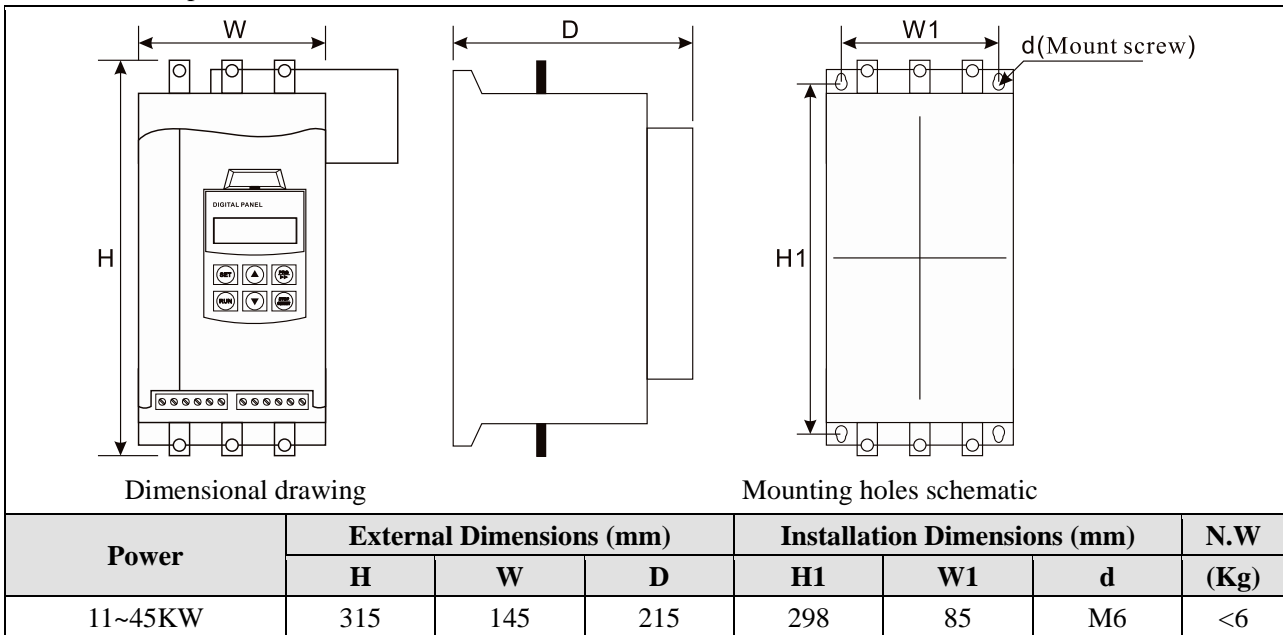

The external shape and installation dimensions of 55KW ~ 250KW.

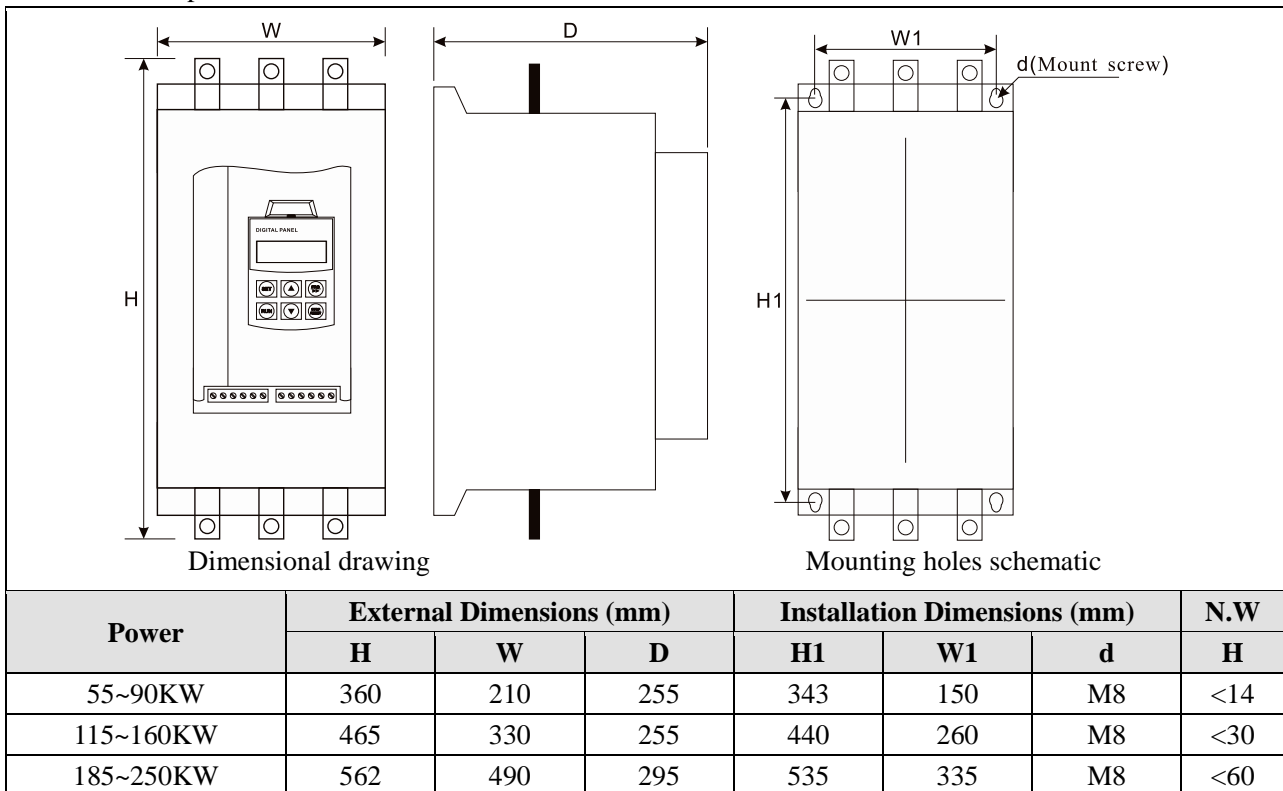

: The rated power of motor in the above form is the maximum rated value. Generally, the values of matched motor power capacity should not be more than this value.

3.4 Installation diagram

The S6000 series online running soft starter has three types of connection as following:

- **Main circuit connection:** It contains the wiring of 3-phase source input, the output to motor.
- **External terminal connection:** That is the wire comes from twelve external terminals which including control signal and analogue output signal.
- **Communication connection:** One standard RJ-45 network cable socket and one DB9 socket can be used to connect computer or network.

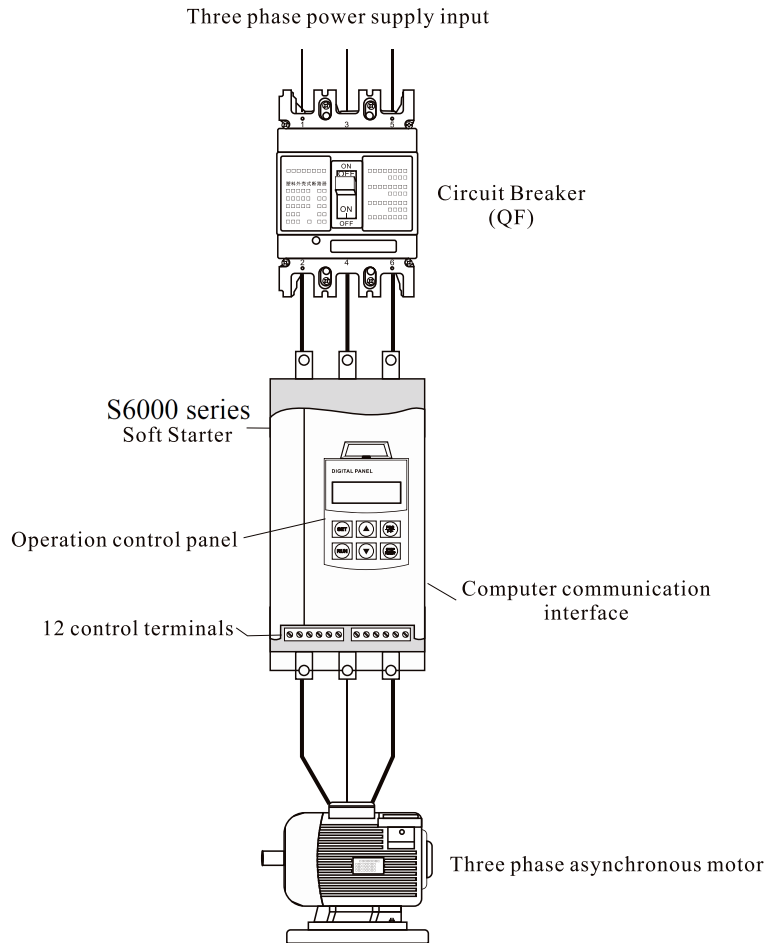

Diagram 3.4

4. Connection and External Terminal

4.1 The external terminal

Please see the diagram diagram 4.2:



Diagram 4.2

No.	Name	Description
①②	Running (by-pass) output	They are normal open contacts and are closed when finishing starting. The terminal contact capacity is AC 250V/5A.
③④	Programmable relay output	The delay time is set by FE code. The output command type is set by FE code. They are normal open no-power terminals, being close when output valid. Please see the detailed information in item 5.3. This terminal contact capacity is AC250V/5A.
⑤⑥	Fault output	They will be closed when there are any fault matters happened to the online running soft starter or electricity lost, while at normal case they are open. This terminal contact Capacity is AC250V/0.5A.
⑦	Instantaneous stop input	This terminal must be connected with terminal ⑩ when the starter works normally. But if these two terminals are open, the online running soft starter will stop, and at this time the starter is at the state of fault protection. This terminal ⑦ can be controlled by the normally closed output terminals of external protection device, and it is useless when the FA code is set to 0(Primary protection).
⑧⑨⑩	External start up or Stop input	There are two ways of connections for your selection; those are 3-wire connection and 2-wire connection, as below: <p>3-Wire connection</p> <p>2-wire connection: Close K will start up Open K will stop</p>
⑪⑫	DC 4 ~ 20mA analog output	They indicate the current value of motor at real-time working. The 20mA is full-scale value and that is four times than rated current of nominal power of online running soft starter, while, we can connect a 4 ~ 20mA DC current meter to check. The max value of output load resistance is 300Ω.

Note: Please make sure that external terminals are in right connection; otherwise, the product may be damaged.

4.3 The communication interfaces

RJ-45 is the standard web line socket.

DB9 socket has RS485 and RS232 interfaces inside.

Please see the diagram 4.4

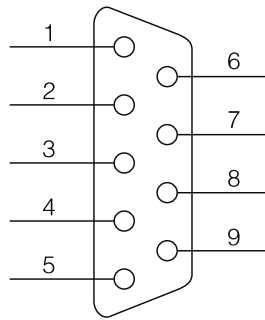

Diagram 4.4

- ① is RS485+
- ⑥ is RS485-
- ② is RS232 output.
- ③ is RS232 input.
- ④ is +5V output (limit-current is 50mA)
- ⑤ is earthed GND.
- ⑦⑧⑨ are empty.

The user can choose the following software:

- Computer collector distribution control communication software.
- Device Net interface card and communication.
- Device Net/Mod-bus/Profi-bus gateways.
- Others.

5. Control Panel and Operation

The online running soft starter has five kinds of working state; Ready ,Run ,Error, Starting and Stopping, the showing parameter is easy to understand and modify.

5.1 The operation of control panel

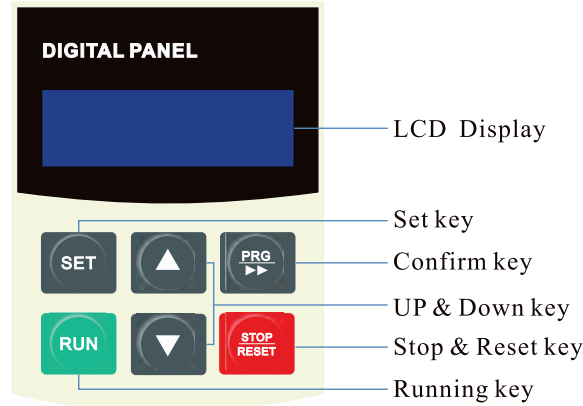





















Diagram 5.1

- Open state: Please do not press the  key until the ready-lamp lights and show *READY*.
- Time-delay state: When the ready-lamp or fault-lamp is shining, it means it is interval time delay; and when the display screen shows "dEXXX" and count down, that means starting time-delay.
- The  or  key: In the process of starting, the panel shows "XXXX" that is the value of start-up current .At this time only  key is valid. And the lamps of ready, Run and Error are all dark, and you can't come into the "Set Menu" and "Help Menu" state. While, in the process of stopping, the panel shows "XXXX" that is the value of motor current. At this time, only  key is valid, and the lamps of Ready, Run and Error are all dark, and you can't come into the "Set Menu" and "Help Menu" state. The  key also has reset function.
- The  key: Press  key to enter the "Set Menu" and panel shows FX:XXX. Please press  key again and Colon is shining, then you can change the parameters after the colon you need. If you want to save the parameter change, please press  key. If you do not want to save, please press the  key until the colon stops shining, then the parameters recover. Having finished the above operation, please press the  key to exit or press  key to exit directly.
- The  key: Under non-Set State, press the  key to enter "Help Menu" and the panel shows HX: XXX. When you finish reading the "Help Menu", you can press  key again or  key to exit. Under Set State, This key can save parameters, and press again can exit set state.
- The "UP"  and "DOWN"  key: In "Set Menu", when the colon is not shining, you can press these two keys to select the Function Code; When colon is shining, you can press these two keys to change parameters. It is the same as the operation in "Help Menu". When the Pass-by -lamp is lighting and the display Screen shows AXXX which means the operation current value of motor, now you can press "UP" or "DOWN" key and the screen will display PXXXX or HXXXX. (PXXXX means the apparent power of motor; HXXXX means the over-load heat balance coefficient, if this value is more than 100%,the screen shows *ERR08*, that means online running soft starter is at state of over-load protection.)

5.2 Parameters set and explanation

The explanation for "Parameter-set" codes.

F0 Initial voltage	Setting range	30-70%	Default	30%
	This code can be used when the starting mode is set as "Voltage ramp to start", and if the motor load is heavy, please set F0=40%, or higher a little. Under "Limit-current" mode, the F0 value will be fixed as 40%.			
F1 Soft starting time	Setting range	2-60s	Default	16s
	It is used to set longest soft starting process time, and soft starting time maybe shorter for different load. It is invalid under "Limit-Current" starting mode.			
F2 Soft stopping time	Setting range	0-60s	Default	0s
	If the code set as "0", the motor will free stop. One soft starter for 2 motor, this code should set "0".			
F3 Start-up time delay	Setting range	0-999s	Default	0s
	Delay is with countdown mode; If set as "0", the starter will start up the motor immediately.			
F4 * Programming time-delay	Setting range	0-999s	Default	0s
	This code is used to set delay time of ③&④ terminals output. Set "0" immediately close. (Please refer to FE for details)			
F5 Start-up current limited value	Setting range	50~500%	Default	400%
	It is used when the starting mode is "current limit", and the value will be fixed as 400% when the starting mode is "Voltage ramp to start"			
F6 * Maximum current of soft starter	Setting range	50~200%	Default	100%
	The "50 ~ 200%" is basic on the nominal current of motor. If the set value of this code over 200%,the online running soft starter will reverse to overheat protection.			
F7 Lower voltage protection	Setting range	40~90%	Default	80%
	When the working voltage is under the voltage range(80%),the online running soft starter will be low voltage protection			
F8 Over voltage protection	Setting range	100~130%	Default	120%
	When the working voltage is over the voltage range(120%),the online running soft starter will be over voltage protection			
F9 Modes of starting	Setting range	0~5	Default	1
	0: Limit-current to start 1: Voltage ramp start 2: Torque control + limit current 3: Torque control + voltage ramp 4: Current ramp start 5: Double closed loop			

FA Protection Level	Setting range	0~4	Default	4
	0. Primary protection 1. Light-load protection 2. Standard protection 3. Heavy-load protection 4. The superior level protection			
FB Operation control mode	Setting range	0~7	Default	1
	0: Run by keypad 1: Run by keypad and terminal 2: Run by terminal 3: Run by terminal and RS485 4: Run by keypad, terminal and RS485 5: Run by keypad and RS485 6: Run by RS485 7: Inhibit start up or stop			
FC Parameter revise	Setting range	0~2	Default	1
	0: Parameter revise prohibit; 1: Partial parameter revise prohibit; 2: All parameter allow revising.			
FD * Communication address	Setting range	0~63	Default	0
	Many online running soft starters connect with upper computer.			
FE* Programming output	Setting range	0~19	Default	6
	Setting the detailed in Item 5.3			
FF* Soft-stopping limited current	Setting range	20~100%	Default	80%
	Setting the detailed in Item 7.3			
FP Motor rated current	Setting range	---	Default	Rated value
	"The rated current of motor" is the same as the motor nominal current. If your motor rated power is much lower than online running soft starter, please revise the FP same as motor rated current. And then online running soft starter can protect small KW motor. If you meet Error 05, please change FA=2.			
FU * Running or By pass suck time	Setting range	0~99s	Default	5s
	This parameter can delay online running soft starter switching to bypass contactor time. If soft starter starts very heavy fan or pump, please set the parameter to 10 or 15 seconds.			
FL * 3 phase balance valid	Setting range	0~1	Default	1
	0: Invalid 1: Valid			

FM *	Setting range	50~150%	Default	100%
Current coefficient	Showing current slants high, to set coefficient down; Lower conversely			
FN *	Setting range	50~150%	Default	100%
voltage coefficient	Showing voltage slants high, to set coefficient down; lower conversely			

Note:

- F6 the "Max working current", is basic on the value of FP (nominal current of motor).
- If you have no any operation for 2 minutes after you come into the "set" state, online running soft starter will exit from "set" state.
- You can not set any parameters in the process of starting or stopping.
- If you press the  key to power on online running soft starter, all parameters will recover to default setting except FE code. When FC=1, these parameters with "*" is prohibited to revise. When FC=2, all parameters can be revised.

5.3 Parameters code function explanation

The parameter Fb is used to set the control ways of online running soft starter; as the following form:

Numerical value	0	1	2	3	4	5	6	7
Keypad	1	1	0	0	1	1	0	0
External terminal control	0	1	1	1	1	0	0	0
RS485 Communication	0	0	0	1	1	1	1	0

Note: In the above form, "1" is allowing, "0" is forbidding. For example, If you press keypad "RUN", and meet *Err 14*, please set Fb=0. And then online running soft starter can be run by keypad.

If the "External Control" is allowing, you must contact a normally closed switch button between the terminal ⑦⑧ and terminal ⑩, otherwise the online running soft starter can't start-up the motor and show "*Err 11/Err 15*".

The parameter FE is use to setting the way of ③&④ programmable relay output, As the following form:

The number setting by FE	The moment of programmable relay output
0(10)	When sending the order of starting , the program output
1(11)	When beginning to start , the program output
2(12)	When at the start of bypass operation, the program output
3(13)	When sending the order of stopping, the program output
4(14)	When finishing the operation of stopping, the program output



If users need programmable relay output time delay, the time can be setting by parameter *F4*.

- When the FE is setting as 5~9(15~19), the terminal ③&④ will display the state of programmable relay output. As the following form:

The number setting by FE	The state of programmable relay output
5(15)	Error state
6(16)	Working state
7(17)	Ready state
8(18)	Starting state
9(19)	By-pass operation state



- The state of programmable relay output is used to show the working state of online running soft starter, and under this way, the **F4** setting delay time is invalid;
- The default setting of **FE** code is "7" showing the ready state of online running soft starter and at this state the motor can be started up;
- When the **FE** code is "5" outputting error state of motor, Terminal ③ ④ can output fault such as: (*Err05*, *Err06*, *Err07*, *Err08*, *Err 12*, and *Err 15*). This will not affect the function of ⑤⑥ error output terminals.
- When **FE** >9, the programmable output will be "reverse phase output", (**Normal open will reverse to normal close**).
- When **FE** =0, all parameters cannot be revised. And when **FC**=1, (*F4*, *F6*, *Fd*, *FE*, *FF*, *FU*) cannot be revised. When **FC**=2, all parameters can be revised.

5.4 Helping message and explanation

When the product is not starting or stopping ,or not at the "set" state, you can press  key and come into helping menu ,then press the "UP" or "DOWN" key to choose the help message. Please press  or  key to return.

Helping message Form

Message displayed	Explanation
<i>U0380</i>	That is the 3-phase power voltage is AC 380V.
<i>030-3</i>	That is the specification is AC 380V, 50Hz, 30A.
<i>H 1E0 1</i>	The fault message Err01 that happened at the last time.
:	:
<i>H9E00</i>	It says no fault happened.
<i>UR-30</i>	It says the software of the products is Ver3.0.
<i>L0000</i>	<i>0000</i> is times of successful soft starting
<i>AUN00</i>	<i>00</i> is last soft starting time
Note: The message H1 ~ H9 displayed means 9 faults records that happened lately.	

- Not in state of soft starting and stopping, and not in setting state, to press  key to enter helping menu, and press "UP" or "DOWN" key to choose helping information.
- Under state of helping, to press  key or  key to quit helping menu.

6. Protection Functions and Directions

We make our online running soft starters have all kinds of protection functions to protect the safety of online running soft starter and the motor. Please choose the correct protection Class and parameters according to your application conditions!

Over-heat protection: When online running soft starter inside temperature is up to $80^{\circ}\text{C} \pm 5^{\circ}\text{C}$, the starter will turn to over-heat protection, when be down to 55°C , this protection removes.

- Input less-phase protection: The delayed time $< 3\text{s}$
- Output less-phase protection: The delayed time $< 3\text{s}$
- Three-phase unbalance protection: The delayed time $< 3\text{s}$, when the difference of current among three phrases is more than $50\% \pm 10\%$, the protection be valid.
- Starting over-current protection time: The diagram of over current 5 times of **F6** set rated working current is just as diagram 6.1.
- Working over-load protection time: The starter will be in inverse time thermal protection on. Base of the Max working current of motor (Set by **F6**), (The diagram 6.1 show)
- Low voltage protection delay time: When power voltage is less than 40%, the protection delayed time $< 0.5\text{s}$;
When power voltage is less than 80%, the protection delayed time $< 3\text{S}$.
- Over-voltage protection delay time: When power voltage is more than 140%, the protection delayed time $< 0.5\text{S}$;
When power voltage is more than 120%, the protection delayed time $< 3\text{S}$.
- Loads short-circuit protection delay time: The protection delayed time $< 0.1\text{S}$.

6.1 Protection classes and explanation

According different usage conditions, S6000 series online running soft starter has five protection classes, as following:

0. Primary protection

1. Light-load protection

2. Standard protection

3. Heavy-load protection

4. The superior protection

- Primary protection includes the protection functions of overheat, short circuit, and input default phase protection and prohibit external instantaneous stop terminal. Which is proper urgently startup conditions, such as fire pump.
- The protections of light load, standard and heavy-load have the overall protection function of soft starter. The difference among them is protection level of overload and over current. See the diagram of 6.1.
- Under the superior protection, the soft starter has a higher protection level.
- The protection classes and the time of heat protection as (diagram 6.1)

FA code	0:Basic protection	1:Light-load protection			2:Standard protection			3:Heavy-load protection			4:Superior protection			Note
The grade of overload protection	No	2 grade			10 grade			20 grade			10 grade			Standard of IEC60947-4-2
The grade of over-current protection	No	3 Second			15 Second			30 Second			15 Second			The 5 times of F6 current
Overload drop-away time	The multiple to the rated current	3	4	5	3	4	5	3	4	5	3	4	5	They are the typical values
	Drop-away time (S)	4.5	2.2	1.5	23	12	7.5	46	23	15	23	12	7.5	

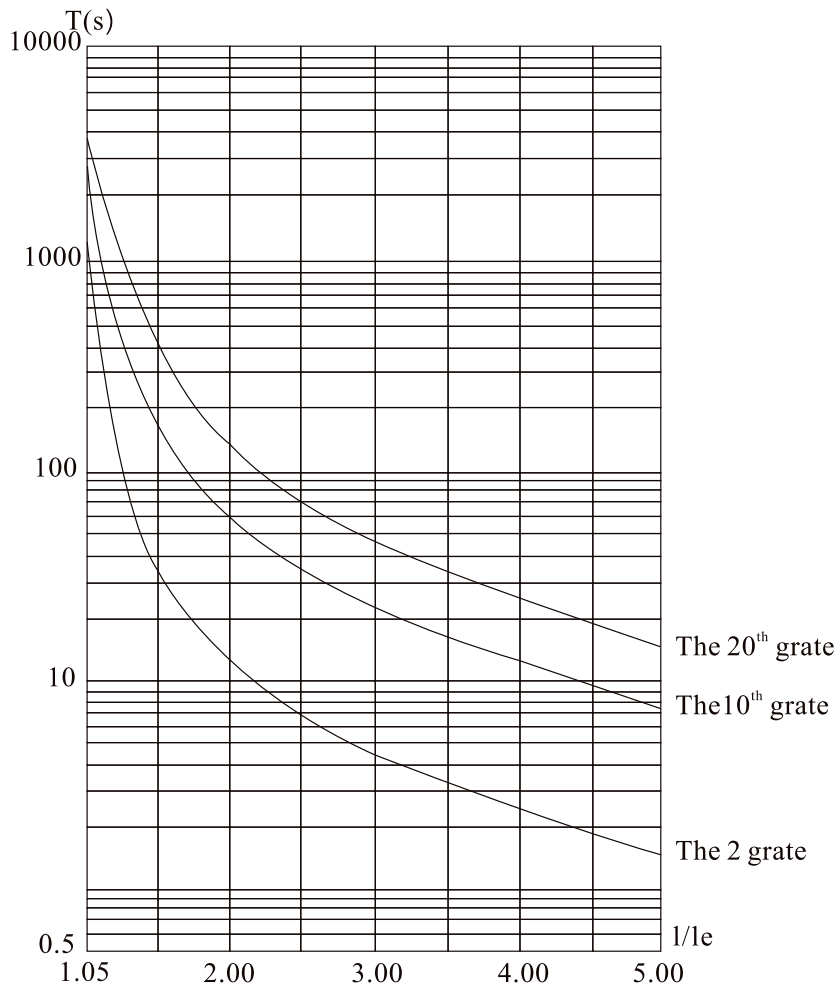

Diagram 6.1 (IEC60947-4-2 standard) Motor heat protection curve (overload drop-away time)

Remark:

- **FP** set value should be same as motor nameplate rated current.



The **FP** set value should not be less than 20% of online running soft starter rated current, otherwise the overheat protection will be useless because of big tolerance.

7. Test Run and Application

Please do some examinations before test running as following:

- Whether the rated power of online running soft starter is matched with the Motor.
- Whether the insulation of motor meets requirement.
- Whether the main circuit connection of input and output is correct.
- Whether all the screws of terminals are twisted tightly.

7.1 Power on to test running

- **After Power on, please do not disassemble the online running soft starter cover that is dangerous!**
- Power on, oft starter displays *READY*, and the Ready is light, then you can press  key to start.
- Set **FP** be same as motor nameplate rated current.
- After started the motor, you should examine whether the motor running direction is correct, or whether runs normally. If not, you can press  key or cut off the power to stop running.
- If the soft starter starting state is not satisfied. Please see the detailed explanation at 7.2: the starting mode and application
- If the start torque is not enough, you can change the starting voltage (when the starting mode is voltage control) or the certain current value (when the mode is current control) to improve start torque.
- Do not open the face cover in case of electric shock.
- If there is any abnormal voice, smoke or taste, please cut off power as soon as fast, and check the reason.
- When the starter power on or be in starting, the error lamp is lighting and screen displays "Err??", at this time, you can check diagram 7.1 to find out reason .
- Press  key or external stop button can reset the error state.

Note: When ambient temperature is less than -10°C , the starter should be power on to preheat for 30 minute, and then to start.

Error Code	Error 00	Fault Type	The fault is removed
Reason and solution	Any faults are removed, such as low-voltage, over-voltage, over-heat. Now the Ready-lamp is lighting and you can start the motor.		
Error Code	Error 01	Fault Type	The external instantaneous stop terminal is open
Reason and solution	Please connect the external instantaneous stop terminal (terminal ⑦) and stop terminal 8 with the public terminal (terminal ⑩) together.		
Error Code	Error 02	Fault Type	The soft starter is over heat
Reason and solution	The soft starter is started too frequently, or the soft starter rated current is smaller than motor, or motor is heavy over load.		
Error Code	Error 03	Fault Type	The starting time is over long, which is longer than 60s.
Reason and solution	The starter parameter is set wrong; or the motor load is heavy, or voltage transformer capacity is not enough; or power supply cable is too long. If soft starter capacity is enough and load is heavy fan or pump, please set FU to 10 or 15 second.		

Error Code	Error 04	Fault Type	Input phase failure
Reason and solution	Please check whether the input circuit connections, bypass contactor and the controlled silicon is open or whether the thyristor wire is not connected.		
Error Code	Error 05	Fault Type	Output phase-failure
Reason and solution	Please check whether the output circuit connection, bypass contactor and the controlled silicon are short circuit, or whether the thyristor wire is connected well; The power supply should connect to R,S,T, and bypass contactor should connect with L1,L2,L3; If motor KW is much smaller than soft starter, please set parameter FA=2.		
Error Code	Error 06	Fault Type	Three-phase unbalance
Reason and solution	Please check the input three-phase power voltage is balance or not, and check the motor 3phase is abnormal. Or set parameter FC=2 and E1=0.		
Error Code	Error 07	Fault Type	Starting over current
Reason and solution	Overload, or the motor is not matched with the soft starter.		
Error Code	Error 08	Fault Type	Running over load
Reason and solution	Overload or the $F5$ code is set wrong.		
Error Code	Error 09	Fault Type	Low voltage
Reason and solution	Please check the voltage of input power or the $F7$ item is set wrong.		
Error Code	Error 10	Fault Type	Over voltage
Reason and solution	Please check the voltage of input power or the $F8$ item is set wrong.		
Error Code	Error 11	Fault Type	The parameters are set wrong
Reason and solution	Please change the parameter correctly, or you can press the  key to power on the starter again to recovery the default setting.		
Error Code	Error 12	Fault Type	Load short circuit
Reason and solution	Check load and the controlled silicon is short circuit or overload.		
Error Code	Error 13	Fault Type	The wiring of automatic Re-start is wrong
Reason and solution	The external terminals is not connected according the 2-wire way.		
Error Code	Error 14	Fault Type	The wiring of external terminal is wrong
Reason and solution	Change $Fb=0$,When external control mode is allowing, the external stop terminal is open, and soft starter cannot start.		

Error Code	Error 15	Fault Type	Motor less load
Reason and solution	Please match the appropriate motor.		
Error Code	Error 16	Fault Type	⑧,⑩ terminal open circuit
Reason and solution	Please check and connect⑧,⑩.		
Note: When the motor starts successfully, ① and ② will close to suck by pass contactor running. At this time, if the contactor is not closed, the motor will stop running, so you can check whether the wiring of the bypass contactor is right.			

7.2 The starting mode and application

The S6000 series soft starter has six starting modes for the user to select according the motor and load equipments.

7.2.1 Current-limit to start

(The $F5$ code is set as"0") Diagram 7.1 shows the waveform of motor current . I1 is the starting limit-current preset value. When starting, the output voltage rises quickly till the motor current up to I1 value and not beyond this value. The motor runs steadily in pace with the rising of output voltage, and when the motor runs to be the rated speed, the output current will have a quick-drop and down to the motor rated current (Ie value),then the bypass contactor is working, the stating process finished.

Note: When motor load is too light or I1 preset value is too high, the max current of starting may can not reach I1 value. This starting mode fits for the conditions which requires strict current limit of starting.

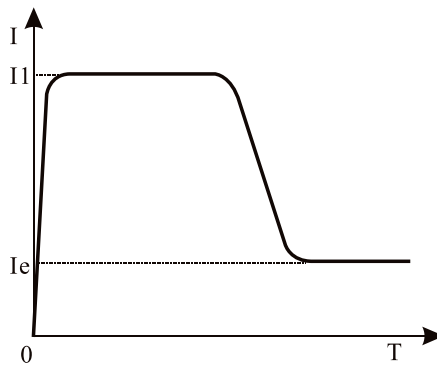

Diagram 7.1

7.2.2 Voltage ramp to start

(The $F9$ code is set as"1") Diagram 7.2 shows the output voltage waveform. In the diagram, the U1 is the initial voltage value of starting. When starting, if the motor current is not more 400% than the rated current, the output voltage of soft starter will rapidly rise to U1, and the output voltage rises gradually to the rated voltage (Ue), and the motor gradually increase and until running at rated voltage and speed, and then the bypass contactor closed, the starting process finished.

Starting time "T" is obtained in the standard experiment under the condition of soft starter with standard load. And soft starter takes this control parameters as a benchmark, smooth acceleration by controlling the output voltage to motor starting process to complete, not mechanically controlled time "T" and regardless smooth of whether the

motor speed. In view of this, when the load is lighter, starting time are often less than the set starting time, as long as can smooth starter is normal

In general, the voltage ramp is generally used mode; it is suitable for requiring higher starting stability without strictly current limitation case.

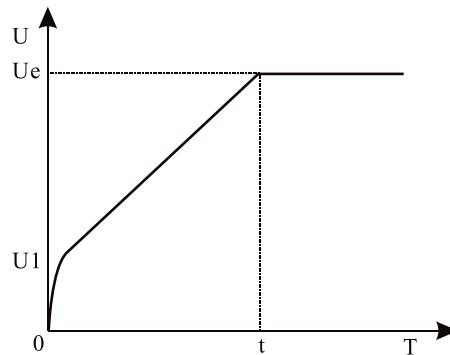

Diagram 7.2

Note: "T" is the automatic detecting starting time according to load. It will be less than set time when the load equipments are light; this starting mode fits for the common occasions where the motor need to be started smoothly.

7.2.3 Torque control + current limit or + voltage ramp to start

(The $F9$ code is set as "2" or "3") Diagram 7.3 and 7.4 shows the output changing waveform of torque control starting mode. When the static friction force of heavy load is too stronger to start the motor, user can use this starting mode. At first state of starting, the motor needs a higher voltage to conquer the static friction force of heavy load, and then starts with current-limit or voltage ramp mode to start the heavy motor.

Note: This mode will cause big-current shock to the motor, so if the voltage ramp or current limit starting mode can startup the motor, it is better not to use this torque control mode to start.

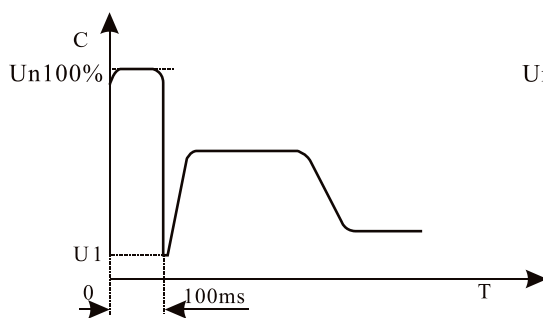

Diagram 7.3

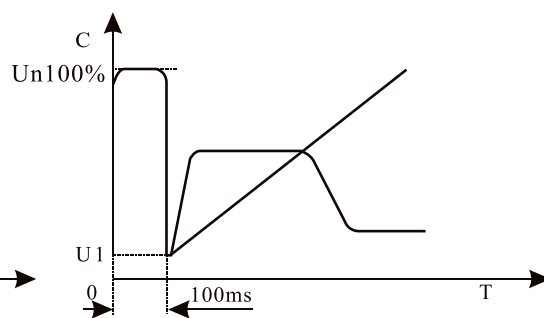

Diagram 7.4

7.2.4 Current ramp to start

(The $F9$ code is set as "4") Diagram 7.5 shows the output current waveform. The I1 in the diagram is current value preset by $F5$ code, and T1 is time value present by $F1$ code. This starting mode has very stronger speed-up ability and is suit for the bipolar motors, and it can reduce the starting time.

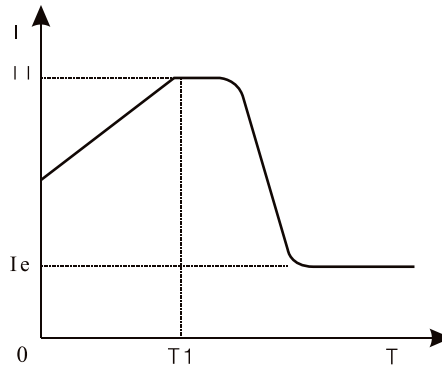

Diagram 7.5

7.2.5 Voltage current-limiting double closed-loop start

(Both voltage ramp and current limit) to start (The $F9$ items set as "5"). This starting mode uses voltage ramp and current limit double closed loop circuit; it is a composite starting mode. The output voltage waveform is changed as different motor and the load equipments. This mode fits for smooth starting and strictly current limit occasions.

7.3 The stopping mode and application

The soft starter has two stopping modes; those are Soft-stopping mode and Free-stopping mode.

7.3.1 Soft-stopping Mode

(The $F2$ item is not set as "0") When using this mode to stop the motor, the power supply of motor will be transferred from the bypass contactor to the controlled silicon of soft starter, and the output voltage of starter will be reduced gradually so that the running speed of motor can be cut down smoothly avoid mechanical shock. The output ending voltage is the same as the starting initial voltage. Soft-stopping mode can reduce or remove the surge of the loading equipments such as the water pump.

You can set the soft-stopping current limit value through the FF code to reduce the high current shock to the motor when stopping. This current limit value is percentage of $F5$.

7.3.2 Free-stopping Mode

(The $F2$ code is set as "0") When using this mode to stop the motor, the soft starter will cut off the connection to the bypass contactor and forbid the controlled silicon output voltage after receiving stopping command. The motor stops gradually with its inertia. One soft start connecting with two motors must use this free stopping mode. Generally, if the soft stopping mode is not necessary, please choose the free stopping mode to prolong the service life of soft starter. This mode completely forbids the instantaneous output; avoid instantaneous high current shock to the motor of specially applying.

7.4 Special application

- **In parallel the starting of the motors:** If the motors total power is less than 80% of soft starter, the motors can be parallel connection. But at this time should be also provides for each motor thermal protection device.
- **Double speed motor:** Motor soft starter can cooperate with double speed motor starting, must go through demagnetization delay period before change from low speed to high speed, to avoid anti-phase current generated between the lines and motor.
- **Too long cable:** f the cable is too long, the cable voltage drop will be high, and that will increase current loss and reduce starting torque, so please use big KW soft starter and motor.

- **Soft starter parallel connected with one power-line:** If several soft starter parallel installed in the one power line, the input line reactor should be installed in the middle of the transformer and the soft starter circuit. Reactor should be installed at each line input side between circuit breaker and soft starter.
- **The application of surge protection device (SPD):** The surge protection device should be considered to installed in the application case, where is easily caused trouble by lightning or other reasons, such as over voltage, over-current, surge interference. Please refer to SPD related documents for details.

7.5 Application examples

The parameters of the different loads are different, please refer to diagram 7.2.

The loading	Voltage ramp starting time(s)	Voltage ramp stopping time(s)	Initial voltage	Voltage ramp (current limit)	Current limit to start
Ball mill machine	20	6	60%	400%	350%
Fan	26	4	30%	400%	350%
Centrifugal	16	20	40%	400%	250%
Piston compressor	16	4	40%	400%	300%
hoister	16	10	60%	400%	350%
Stirring machine	16	2	50%	400%	300%
Breaker	16	10	50%	400%	350%
Screw compressor	16	2	40%	400%	300%
Rotating conveyor	20	10	40%	400%	200%
Light load	16	2	30%	400%	300%
Convey belt	20	10	40%	400%	250%
Heat pump	16	20	40%	400%	300%

8. Online Running Soft Starter Cabinet

Online running soft start cabinet is mainly used for all kinds of high power motor startup, using the soft start to replace the traditional starting way to realize smooth starting, reduce the starting current, reduce larger electric current of motor starting mechanical shock, and reduce the impact on the power grid, improve power quality and save energy. Using protection of locked-rotor and fast responsibility to avoid motor overheating or burning caused by mechanical failure or locked-rotor fault, reduce the voltage drop caused by large starting current which affect other electrical appliances, reduce wear and prolong the service life of the motor, saving machinery maintenance.

8.1 Product Function

- Online running soft start cabinet adapts various occasions. According to customer requirements to single motor startup, more machines startup at the same time, many motors sequence delay startup function.
- Soft stop function: can choose free stopping or soft stopping.
- It can protect own system and the bypass contactor, and has 12 kinds of protections for motor. Such as short circuit protection, overload protection, over current, input or output phase lost.
- With a variety of control modes. It can be controlled by keypad, also can be remote controlled, and also can be inter-locked with other equipments; Equipped with communication interface (optional), easy to realize automatic control. Current and voltage double closed loop control, it is suitable for all kinds of motor. Starting current and voltage both can be adjusted.
- LCD screen for English language displaying interface, parameter setting, convenient inquiry, working state real time displaying.
- Soft starting slope and maintain time adjustable, can adapt to low voltage or small transformer capacity occasion.

The usage condition

- **Power Supply:** City grid power, self-provided power, diesel oil dynamotor, 3-phase alternating current 220V/380V/480V/660V \pm 15%, 50Hz or 60Hz. The power capacity of the soft start must meet the motor starting requirement.
- The power supply capacity must satisfy the requirement of the soft starter for motor starting.
- **Matched Motor:** Motor should be three phase squirrel asynchronous motor, and its power capacity must be matched with soft starters.
- **Starting Frequency:** The starting time is according to the loading equipments, less than 20 times per hour with full load.
- **Cooling Mode:** fan compelled wind cooling.
- **Protective Grade:** IP20
- **Environment Conditions:** when altitude is less than 1000m, the temperature of the environment should be between -25°C ~ 45 °C, relative humidity should be less than 90% RH, no vapor, no flammable, volatile, corrosive gas. No electric dirt, indoor installation, ventilated, vibration is less 0.5G. Soft starter should de-rate power above altitude of 2000 meters.

8. The structure and installation method

By floor vertical installation, can be installed above the groove, the power cables and control cables introduced from groove into control cabinet. The cabinet body used angle steel framework, control cabinet front and back can open the door, the cabinet appearance adopted powder painting processing, and its model and size is in the following table.

Model	Voltage	Power	Current	External Dimensions (mm)		
	(V)	(KW)	(A)	W	D	H
18.5-Z	380	18	37	420	380	1000
022-Z	380	22	45	420	380	1000
030-Z	380	30	60	420	380	1000
037-Z	380	37	75	420	380	1000
045-Z	380	45	90	420	380	1000
055-Z	380	55	110	420	380	1100
075-Z	380	75	150	420	380	1100
090-Z	380	90	180	450	450	1100
115-Z	380	115	230	600	500	1200
132-Z	380	132	260	600	500	1200
160-Z	380	160	320	600	500	1200
185-Z	380	185	370	600	500	1200
200-Z	380	200	400	600	500	1200
220-Z	380	220	450	700	500	1450
250-Z	380	250	500	700	500	1450
280-Z	380	280	560	700	500	1450
320-Z	380	320	630	700	500	1450
355-Z	380	355	710	700	500	1450
400-Z	380	400	800	700	500	1700
450-Z	380	450	900	700	500	1700
500-Z	380	500	1000	700	500	1700
600-Z	380	600	1200	700	500	1700

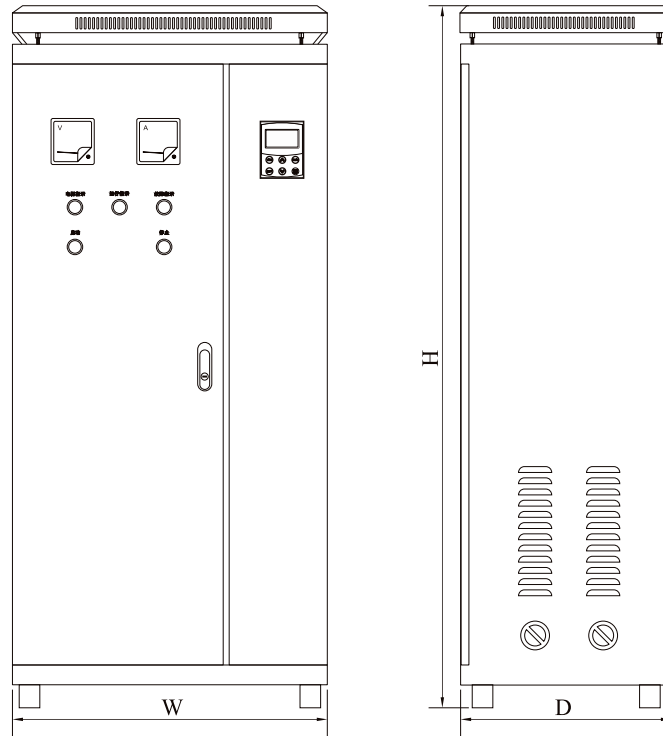

8.3 The operation of control panel

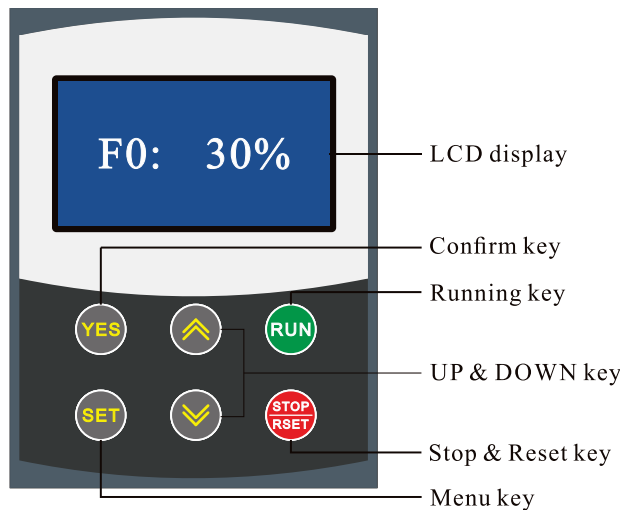

Diagram 5.1

- Power on : Will show "READY", press **RUN** key can soft start motor。 The state "READY" means soft starter is ready for starting.

The keypad key specification:

- **RUN** key and **STOP&RSET** key: In the soft starting process, keypad will show "A:***" displaying motor current, at this moment, only **STOP&RSET** key is valid, and cannot enter menu of parameter setting and helping. In the soft stopping process, the keypad will show "A:***", displaying motor current, at this moment, only **RUN** key is valid, and cannot enter menu of parameter setting and helping, **STOP&RSET** key also has function of fault reset.

- **SET** key: under non-helping state, to press **SET** key enter setting menu, displaying initial voltage F0:30%, and press **SET** key again, the colon behind F0 flashing, means the parameter behind colon is revisable, and press **UP** key or **DOWN** key to change parameter. And then press **YES** key to save, the screen will show "GOOD" and ring two, means parameter saved, and then quit. If you do not want to save new parameter, to press **SET** key, the colon stop flashing and recover old parameter, and to press **YES** key to quit, also can directly go back to main menu by pressing **STOP&RSET** key.
- **YES** key: Under non-setting state, press **YES** key to enter helping menu, displaying power voltage "AC:XXXXV", and press **YES** key to quit, and also can press **STOP&RSET** key quit. Under setting state, to press **YES** key to save new parameter and quit setting state.
- **UP** key and **DOWN** key: Under setting menu, when the colon no-flashing to press **UP** key or **DOWN** key can change parameter code, when colon flashing: **UP** key or **DOWN** key to change this parameter value; pressing **UP** key or **DOWN** key over 1 second, the parameter value will rapidly change. Under helping menu to press **UP** key or **DOWN** key can change function code and helping information. When the soft starter is starting, and do not enter setting and helping menu, the keypad will display motor current "A:***", at this time to press **UP** key or **DOWN** key, can check apparent power "XXX.XKW" or over load ratio "XXX.X%", when the overload ratio over 100%, starter will stop and alarm over load, the keypad displaying "Error 8".
- There will be a sound when pressing key is valid, no sound means this key is invalid under this state.
- when external control way use 3 wiring, the terminal start button and stop button is same function as keypad **RUN** key and **STOP&RSET**.
- Control keypad adopts super-strong anti-interference design, allowing the extending cable distance longer than 3 meters.

8.4 Operation procedures and cautions

Operation procedures:

- Be sure to read the manual, operation procedures and cautions before use soft starter.
- Before power on soft starter cabinet, please open the cabinet door, and switch on breaker, when the cabinet power indicator (red lamp) light, means cabinet has been power on, and soft starter is on ready state.
- Should check the motor wiring before startup.
- press the "start" button after confirmed, the operation indicator (green light) on, the motor starts to run.
- When press the "stop" button, the motor will free stopping (if preset soft stopping time, the motor will soft stopping), and the running indicator (green light) off.

Parameter setting:

- Parameters setting is same as online soft starter, please refer to the online soft starter parameter Settings on page 10.

Caution:

- Online soft start cabinet before work, must close the main power circuit breaker.
- When power or operation, the fault indicator (yellow light) on soft start cabinet, said malfunction for online soft start cabinet or motor with the load, should stop check the fault reason, after solved the fault to restart.

Quality Warranty

The warranty of soft starter is as follows:

(1) Warranty period under normal conditions.

We provide guarantees for repair and replacement in 1 month from the date of use.

We provide guarantee for repair in 12 months from the date of use or 18 month from the date of ex-factory.

(2) The purchaser enjoys life-long paid service whenever and wherever he uses a motor soft starter made in our company.

(3) Service in the following cases, even within the warranty period, shall be charged to the purchaser:

Problems caused by mal-operation in violation of this manual, or caused by unauthorized repair or renovation.

Problems caused by improper use of soft starter that is off standard and requirement;

Malfunction or damage caused by improper transit or storage after purchase;

Induced failure or aging of the device due to poor ambient;

Malfunction or damage caused by fire, flood, thunder, earthquake, abnormal voltage or other natural disasters;

Unidentifiable nameplate, mark and ORD number due to intentional spoilage;

Delayed or unsatisfied payment in violation of purchase appointment;

Fail to give an objective description on the use of installation, wiring, operation, maintenance or else;

(4) Defective products should be sent to us for repair, replacement and return, which can be proceeded only after verifying the burden of liability.

(5) In case there is any quality problem or accident, we merely promise to bear the above-mentioned responsibilities. If a user needs more guarantees for liabilities, please assure on the insurance company voluntarily.

Product Warranty Card	
Customer Information	Company address:
	Company Name: Contact Person:
	Post Code: Tel:
Product information	Product model:
	Body barcode (Attach here):
	Name of agent:
Failure information	(Maintenance time and content):
Maintenance personnel:	